

CIMC TANK



Authorized Distributor:
Pacific Marine & Industrial
www.pacificmarine.net
info@pacificmarine.net

罐箱零配件手册

TANK CONTAINER SPARE PARTS



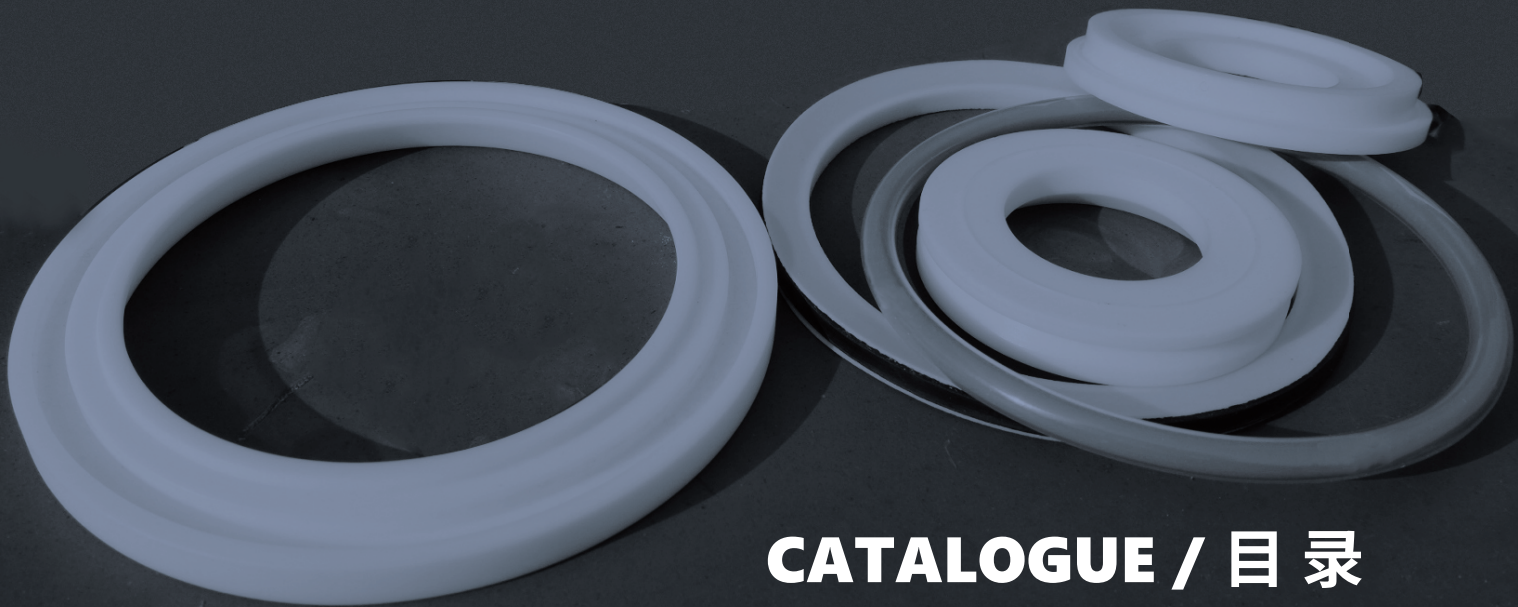

CATALOGUE / 目录

Walkway Assemblies / 步道组件	02
Cladding and Insulation / 外包板及保温	03
Manlid assemblies / 人孔组件	04
Valve / 阀件	05
Other Component / 其他组件	06



Authorized Distributor:
Pacific Marine & Industrial
www.pacificmarine.net
info@pacificmarine.net

WALKWAY ASSEMBLIES

步道组件 FOR TANK CONTAINER USE. / 适用于罐式集装箱

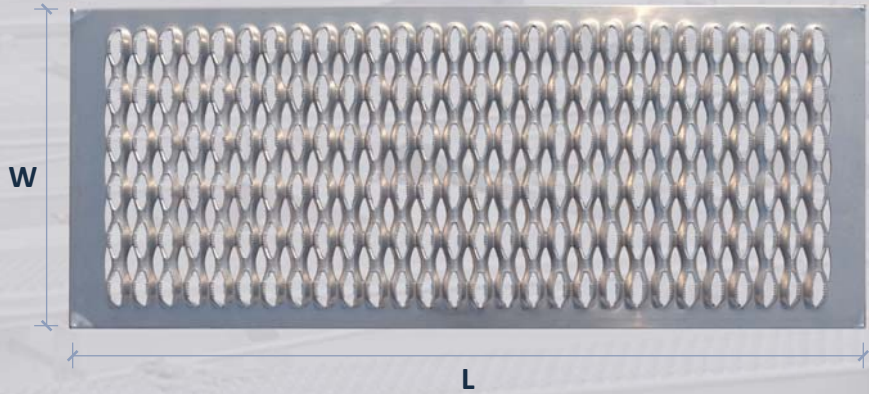
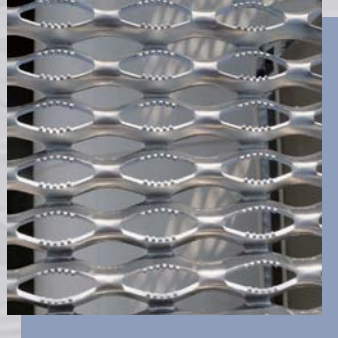
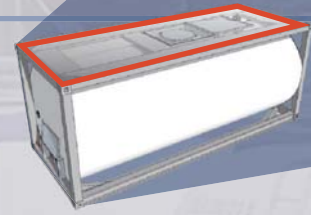

NAME

产品名称

Walkway / 步道

DESCRIPTION

产品参数

MATERIAL

产品材质

Aluminum / 铝合金

MANUFACTURER

生产商

CIMC

PART NO. / 产品编号	SIZE / 尺寸 (W×H×L)	THICK / 厚度
CW475-58	475mm×58mm×5800mm	3.0mm
CW400-58	400mm×58mm×5800mm	
CW475-48	475mm×48mm×5800mm	
CW400-48	400mm×48mm×5800mm	
CW300-58	300mm×58mm×5800mm	
CW300-48	300mm×48mm×5800mm	



Authorized Distributor:
Pacific Marine & Industrial
www.pacificmarine.net
info@pacificmarine.net

CLADDING & INSULATION

外包板及保温 FOR TANK CONTAINER USE. / 适用于罐式集装箱

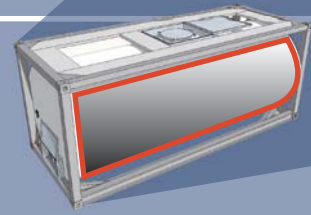

MANUFACTURER

生产商

■ CIMC

CLADDING
外包材料

CLADDING FOR BARREL / 筒体

PART NO. 产品编号	PMATERIAL 材质	SIZE(W×L) 规格(宽×长)	THICK 厚度	COLOUR 颜色
CC-001	GRP	1475mm×50m	1.8mm	RAL9010,RAL9003
CC-002		1475mm×50m		others
CC-003		1475mm×50m	2.0mm	RAL9010,RAL9003
CC-004		1475mm×50m		others
CC-005	ST.ST. / 不锈钢	1219mm×50m	0.8mm	Mirror surface
CC-006	Aluminum / 铝合金	1430mm×50m	0.8mm	Original color, Paining color

CLADDING FOR DOME END / 端部

	PART NO. 产品编号		PART NO. 产品编号	CC-008
	CC-007		GRP ball type for collar tank 21KL-26KL 适配于21KL至26KL框架式罐箱	
	GRP sector type for beam tank. 适配于梁式罐箱		PART NO. 产品编号	CC-009
	GRP ball type for swapbody 适配于swapbody罐箱			

CLADDING BANDING / 外包钢带

	PART NO. 产品编号	CB-001	PMATERIAL 材质	ST.ST. 不锈钢
	SIZE(W×T×L) 规格(宽×厚×长)	50mm×0.8mm×50m	COLOUR 颜色	Mirror surface 镜面

INSULATION
保温材料

ROCK WOOL / 岩棉

PART NO. 产品编号	CR-001
SIZE(L×W×T) 规格(长×宽×厚)	1200mm×600mm×50mm
DENSITY 容重	40K



Authorized Distributor:
Pacific Marine & Industrial
www.pacificmarine.net
info@pacificmarine.net

MANLID ASSEMBLIES

人孔组件 FOR TANK CONTAINER USE. / 适用于罐式集装箱

装料时液碱温度
不超过50℃



Authorized Distributor:
Pacific Marine & Industrial
www.pacificmarine.net
info@pacificmarine.net

MANLID ASSEMBLIES

人孔组件 FOR TANK CONTAINER USE. / 适用于罐式集装箱

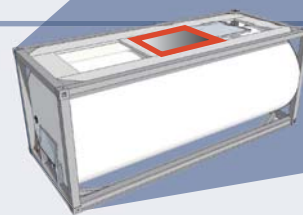

MANLID COVER/ 人孔盖

PART NO. / 产品编号	DESCRIPTION/ 规格
CM-001	500mm standard manlid cover
CM-002	300mm standard manlid cover
CM-003	Flat manlid cover



MANLID COVER/ 平人孔

PART NO. / 产品编号	DESCRIPTION/ 规格
CM-001	Standard manlid cover



MANLID NECKRING/ 人孔颈圈

PART NO. / 产品编号	DESCRIPTION/ 规格
CO-001	500mm standard manlid neckring
CO-002	300mm standard manlid neckring



Authorized Distributor:
Pacific Marine & Industrial
www.pacificmarine.net
info@pacificmarine.net

MANLID ASSEMBLIES

人孔组件 FOR TANK CONTAINER USE. / 适用于罐式集装箱

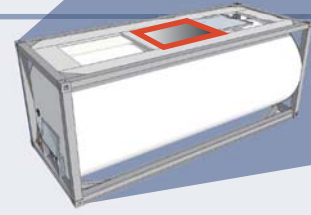

MANLID GASKET
人孔垫圈

SUPERTANKTYT/ 超级密封垫

	PART NO. / 产品编号	SIZE / 规格	MATERIAL / 材质	THICK / 厚度
	CMS-001	500mm	PTFE/EPDM	12mm or 14mm
	CMS-002	500mm	PTFE/HT NITRILE	
	CMS-003	300mm	PTFE/EPDM	

BRAIDED MANLID SEAL/ 编制型人孔垫圈

	PART NO. / 产品编号	SIZE / 规格	MATERIAL / 材质
	CMB-001	14X14X1650mm	BRAIDED PTFE SEAL
	CMB-002	14X14X1650mm	BRAIDED PTFE SEAL silicone core inside

WHITE RUBBER SEAL/ 食品级人孔垫圈

	PART NO. / 产品编号	SIZE / 规格	MATERIAL / 材质
	CMW-001	500mm 16mm×10mm	White sweet rubber manlid seal
	CMW-002	300mm 16mm×10mm	

EYEBOLT PIVOT PIN/ 转轴



Swingbolt Pin 16mm

MANLID/NECK HINGE PIN ASSEMBLY/ 铰链

Manlid Hinge Pin Assembly
人孔盖铰链销装配



16MM LOCKING MANWAY HINGE PIN/ 插销

Anti Theft Manlid Hinge
人孔盖插销



Naval Brass
黄铜



ST/ST
不锈钢

SWING BOLT/ 蝶形螺栓

	PART NO. / 产品编号	TYPE / 型号	LENGTH / 长度
	CSB-001	16 BSW S'BOLT	66mm
	CSB-002		87mm
	CSB-003		95mm
496/1260	16 ST.ST. S'BOLT	66mm	
496/1260	16 ST.ST. S'BOLT	87mm	
496/1260	16 ST.ST. S'BOLT	95mm	



Authorized Distributor:
Pacific Marine & Industrial
www.pacificmarine.net
info@pacificmarine.net

FLANGE GASKET

法兰垫片 FOR TANK CONTAINER USE. / 适用于罐式集装箱

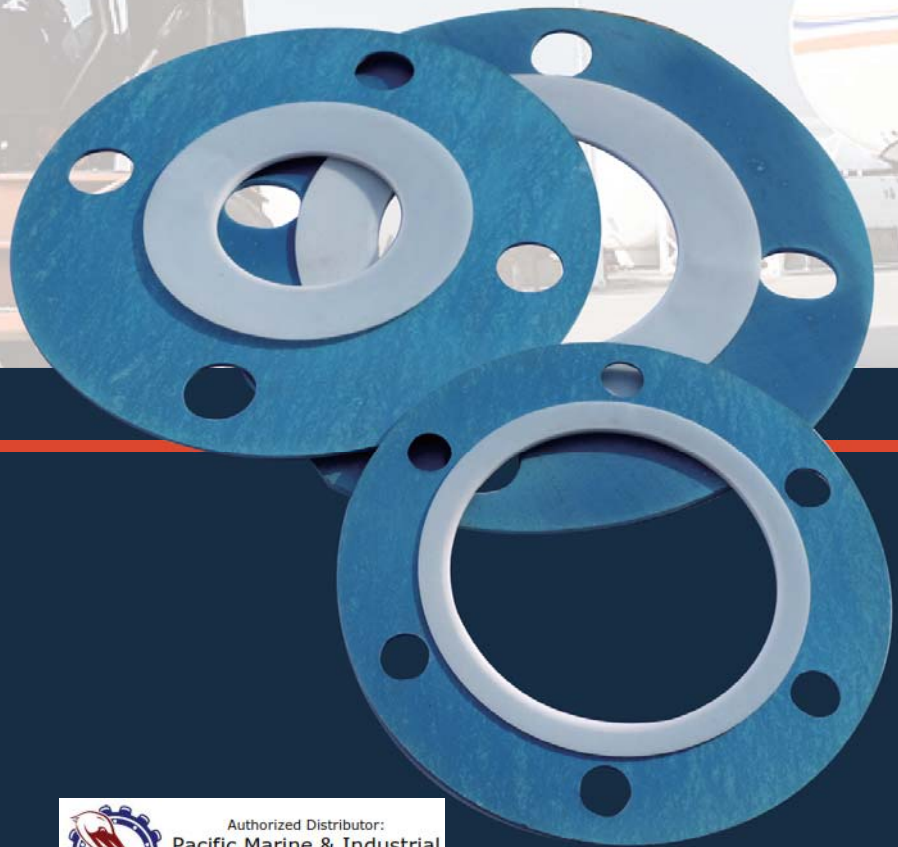

Authorized Distributor:
Pacific Marine & Industrial
www.pacificmarine.net
info@pacificmarine.net

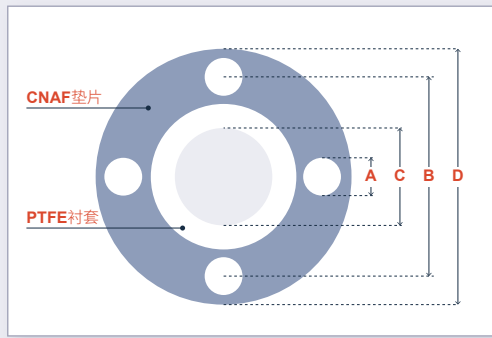

CG-001 	Material 材质	CNAF/PTFE		
	Thickness 厚度	2.5MM		
	NO. of Holes 孔数	-		
	A Hole Φ	-	B PCD	-
	C Internal Φ	80mm	D External Φ	130mm
Application 适配	Flange gasket / Clamped butterfly 45°/90°速流式/提升式底阀入口			

CG-002 	Material 材质	CNAF/PTFE		
	Thickness 厚度	2.5MM		
	NO. of Holes 孔数	8		
	A Hole Φ	14	B PCD	178
	C Internal Φ	114	D External Φ	203
Application 适配	3' Foot valve / Tank pad 3寸足阀 / 罐体法兰			

CG-003 	Material 材质	CNAF/PTFE		
	Thickness 厚度	2.5MM		
	NO. of Holes 孔数	4		
	A Hole Φ	18	B PCD	125
	C Internal Φ	50	D External Φ	160
Application 适配	2' Ball valve / Tank pad 2寸球阀 / 罐体法兰			

CG-004 	Material 材质	CNAF/PTFE		
	Thickness 厚度	2.5MM		
	NO. of Holes 孔数	4		
	A Hole Φ	18	B PCD	172
	C Internal Φ	127	D External Φ	203
Application 适配	3' Top outlet valve / 3' Foot valve / Tank pad 3寸顶 outlet 阀 / 3寸角阀 / 罐体法兰			

CG-005 	Material 材质	CNAF/PTFE		
	Thickness 厚度	2.5MM		
	NO. of Holes 孔数	6		
	A Hole Φ	11	B PCD	105
	C Internal Φ	75	D External Φ	125
Application 适配	2.5' Flanged PRV / Tank pad 2.5寸法兰式安全阀 / 罐体法兰			

CG-006 	Material 材质	CNAF/PTFE		
	Thickness 厚度	2.5MM		
	NO. of Holes 孔数	6		
	A Hole Φ	14	B PCD	168
	C Internal Φ	102	D External Φ	203
Application 适配	3' Top outlet provision 3寸顶 outlet			

CG-007 	Material 材质	CNAF/PTFE		
	Thickness 厚度	2.5MM		
	NO. of Holes 孔数	4		
	A Hole Φ	18	B PCD	146 min
	C Internal Φ	83	D External Φ	190
Application 适配	Outlet of 3' flanged / Butterfly valve 3寸出口法兰 / 蝶阀			

CG-008 	Material 材质	CNAF/PTFE		
	Thickness 厚度	2.5MM		
	NO. of Holes 孔数	4		
	A Hole Φ	18	B PCD	144 min
	C Internal Φ	82.5	D External Φ	190
Application 适配	3' Flange PRV / Tank pad 3寸法兰式 安全阀 / 罐体法兰			

CG-009 	Material 材质	CNAF/PTFE		
	Thickness 厚度	2.5MM		
	NO. of Holes 孔数	4		
	A Hole Φ	18	B PCD	178
	C Internal Φ	114	D External Φ	216
Application 适配	3' Foot valve / Tank pad 3寸足阀 / 罐体法兰			

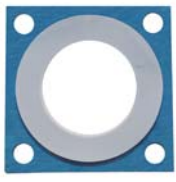
CG-010 	Material 材质	CNAF/PTFE		
	Thickness 厚度	2.5MM		
	NO. of Holes 孔数	4		
	A Hole Φ	18	B PCD	160
	C Internal Φ	83	D External Φ	144
Application 适配	Inlet of 3' clamped / Butterfly valve 3寸夹持式 outlet 口垫片 / 蝶阀			

CG-011 	Material 材质	CNAF/PTFE		
	Thickness 厚度	2.5MM		
	NO. of Holes 孔数	4		
	A Hole Φ	18	B PCD	160
	C Internal Φ	89	D External Φ	144
Application 适配	Outlet of 3' flanged / Butterfly valve 3寸出口法兰 / 蝶阀			

CG-012 	Material 材质	CNAF/PTFE		
	Thickness 厚度	2.5MM		
	NO. of Holes 孔数	6		
	A Hole Φ	14	B PCD	168
	C Internal Φ	102	D External Φ	203
Application 适配	3' Flanged butterfly valve / Tank pad 3寸法兰蝶阀 / 罐体法兰			

CG-013 	Material 材质	PTFE		
	Thickness 厚度	-		
	NO. of Holes 孔数	-		
	A Hole Φ	-	B PCD	-
	C Internal Φ	-	D External Φ	-
Application 适配	1.5' Airline valve 1.5寸空气阀			

CG-014 	Material 材质	PTFE		
	Thickness 厚度	-		
	NO. of Holes 孔数	-		
	A Hole Φ	-	B PCD	-
	C Internal Φ	-	D External Φ	-
Application 适配	3' Main seal of butterfly valve 3寸蝶阀主密封			

CG-015 	Material 材质	CNAF/PTFE		
	Thickness 厚度	2.5MM		
	NO. of Holes 孔数	4		
	A Hole Φ	18	B PCD	146
	C Internal Φ	83	D External Φ	190
Application 适配	Outlet of 3' flanged butterfly valve 3寸出口法兰蝶阀			

CG-016 	Material 材质	CNAF/PTFE		
	Thickness 厚度	2.5MM		
	NO. of Holes 孔数	-		
	A Hole Φ	-	B PCD	-
	C Internal Φ	-	D External Φ	-
Application 适配	2.5' BSP PRV / Tank pad 2.5寸BSP安全阀 / 罐体法兰			

CG-017 	Material 材质	CNAF/PTFE		
	Thickness 厚度	2.5MM		
	NO. of Holes 孔数	-		
	A Hole Φ	-	B PCD	-
	C Internal Φ	-	D External Φ	-
Application 适配	Ring for PRV / Foot valve 足阀、安全阀、O型圈			



Authorized Distributor:
Pacific Marine & Industrial
www.pacificmarine.net
info@pacificmarine.net

OTHER COMPONENT

其他组件 FOR TANK CONTAINER USE. / 适用于罐式集装箱



Authorized Distributor:
Pacific Marine & Industrial
www.pacificmarine.net
info@pacificmarine.net



OTHER COMPONENT

其他组件 FOR TANK CONTAINER USE. / 适用于罐式集装箱

DUST CAP / 防尘盖

PART NO. / 产品编号	SIZE / 尺寸	MATERIAL / 材质
CDC-001	1' dust cap with chain	ST.ST.316/304 不锈钢
CDC-002	1.5' dust cap with chain	
CDC-003	2' dust cap with chain	
CDC-004	3' dust cap with chain	





OTHER COMPONENT

其他组件 FOR TANK CONTAINER USE. / 适用于罐式集装箱

DESCRIPTION

产品参数

	PART NO. / 产品编号	DESCRIPTION / 规格	MATERIAL / 材质
CORNER POST / 角柱	COP-001	500mm	Carbon steel
CORNER CASTING / 角件	COC-001	500mm	Carbon steel
HANDRAIL / 扶手栏杆	CH-001	standrad for ISO tank	ST.ST.
	CH-002	bottom operated for ISO tank and swapbody	ST.ST.

DIAGRAMS

示意图





OTHER COMPONENT

其他组件 FOR TANK CONTAINER USE. / 适用于罐式集装箱



DOCUMENT BOX/ 文件筒

PART NO. / 产品编号	DESCRIPTION/ 规格
CDB-001	Plastic, white, φ75×325mm
CDB-002	Plastic, white, φ110×300mm

DATA PLATE/ 铭牌

PART NO. / 产品编号	DESCRIPTION/ 规格
CDP-001	ST.ST. flat type
CDP-002	ST.ST. bend type



SPILL BOX COVER/ 溢流盒盖

PART NO. / 产品编号	DESCRIPTION/ 规格
CSBC-001	ST.ST. 304, customized size
CSBC-002	Aluminum, customized size

THERMOMETER/ 温度计



● CT-001

ST.ST.
-40°C~160°C

PRESSURE GAUGE/ 压力表



● CPG-001

ST.ST.
0~7Bar
2.5' Dia 1/4" BSP

RUPTURE DISC/ 爆破片



● CRD-001

ST.ST.
0~7Bar
2.5' Burst disc 4.84bar @ 20°C
3' Burst disc 4.84bar @ 20°C

DECAL HOLDER/ 标贴框



● CDH-001

Aluminum

LADDER/ 扶梯



● CL-001

ST.ST.
Removeable

LEVEL GAUGE/ 液位计



● CLG-001

ST.ST.
Removeable



Authorized Distributor:
Pacific Marine & Industrial
www.pacificmarine.net
info@pacificmarine.net

VALVE ASSEMBLIES

阀件 FOR TANK CONTAINER USE. / 适用于罐式集装箱





VALVE ASSEMBLIES

阀件

FOR TANK CONTAINER USE. / 适用于罐式集装箱



2.5'/3' Flanged pressure

2.5' /3 '法兰式安全阀

材质:316不锈钢
重量:5.5KG



2.5' BSP pressure relive valve

2.5' BSP高流量安全阀

材质:316不锈钢
重量:2.2KG



Fusible link assembly

熔断器

设计温度:100°C
重量:0.5KG



Flanges

不锈钢法兰



Blind Flange

不锈钢盲板



Blind Flange

不锈钢盲板



2' Ball valve

2' 球阀

材质:316不锈钢、PTFE密封件
重量:4.7KG



1.5' BSP airline

1.5' BSP放空阀

材质:316不锈钢、PTFE密封
重量:1.8KG



Adapot flange

过渡法兰

材质:316不锈钢
重量:12.18KG



3' Clean flow bottom valve

3' 净流底阀

材质:316不锈钢
重量:12KG



3' Unit valve

3' 一体提升式底阀

材质:316不锈钢
重量:12.18KG



3' Highlift bottom valve









3' highlift底阀

材质:316不锈钢
重量:12.18KG



RAIL	TOP RAILS	m		
	BOTTOM RAILS	m		
COLUMN	COLUMN	m	2.6m	
CORNER CASTINGS	CORNER CASTING	mm	178*162*118mm	
CLADDING	CLADDING	GRP	6X15m之内	
DOCUMENT HOLDER	DOCUMENT HOLD	plastic	75mm plastic	
			75mm clear plastic	
			110mm plastic	
			110mm clear plastic	
DATA PLATE	DATA PLATE	stainless steel	0.8X290X474mm	
			0.8X100X200mm	
			0.8X200X250mm	
			0.8X210X270mm	
BURSTING DISCS	BURSTING DISCS	size, pressure	50mm, 2.20-2.42 Bar@20°C	
			50mm, 2.76-3.10 Bar@20°C	
			65mm, 2.14 Bar@20°C	
			65mm, 2.28 Bar@20°C	
			65mm, 2.41 Bar@20°C	
			65mm, 2.69 Bar@20°C	
			65mm, 2.96 Bar@20°C	
			65mm, 3.1 Bar@20°C	
			65mm, 3.67 Bar@20°C	
			65mm, 4.1 Bar@20°C	
			65mm, 4.4 Bar@20°C	
			65mm, 4.84 Bar@20°C	
			80mm, 3.67 Bar@20°C	
			80mm, 4.1 Bar@20°C	
			80mm, 4.84 Bar@20°C	
			80mm, 6.62 Bar@20°C	
			80mm, 7.58 Bar@20°C	
			89mm, 12.1 Bar@55°C	
			89mm, 13.8 Bar@55°C	
			89mm, 15.0 Bar@55°C	
			89mm, 21.0 Bar@55°C	
			89mm, 22.0 Bar@55°C	
			89mm, 27.5 Bar@55°C	
			89mm, 34.5 Bar@55°C	



GAUZES	FLAMEPROOF GAUZE	size	1" gauze ring	
			1&1/2" gauze ring	
			2&1/2" gauze ring	
GAUGES	PRESSURE GAUGES	MPa/ bar	0-6bar, 1/4"BSP connection, brass internal, glycerin filled	
			0-6bar, 1/4"BSP connection, st.st. internal, glycerin filled	
			0-10bar, 1/4"BSP connection, , brass internal, glycerin filled	
			0-10bar, 1/4"BSP connection, st.st. internal, glycerin filled	
	THERMOMETER/ THERMISTOR	°C	Analogue Temperature Gauge with 2500mm capillary. Silicone oil filled. Range : -20°C to 200°C	
			Analogue Temperature Gauge with 2500mm capillary. Silicone oil filled. Range : -20°C to 200°C	
			Analogue Temperature Gauge with 250mm st/st tube & brass thermo well probe. Range : -20°C to 200°C	
			Digital Temperature Gauge with 2500mm capillary. Range : -50°C to 200°C / -58°F to 392°F	
WALKWAY	WALKWAY	Catwalks	240X40X5800mm	
			300X40X5800mm	
			400X40X5800mm	
			400X50X5800mm	
			400X75X5800mm	
			480X40X5800mm	
			480X50X5800mm	
			480X65X5800mm	
			480X75X5800mm	
LADDER	LADDERS	mm	450X2000mm	
SEALS AND GASKETS	MANLID SEALS	size, material	300mm rubber	
			500mm rubber	
			300mm PTFE	
			500mm PTFE	
	VALVE SEALS	size, material	1&1/2" ball valve seal, PTFE	
			2" ball valve seal, PTFE	
			2" butterfly valve, PTFE	
			2&1/2" relief valve, PTFE	
			3" ball valve seal, PTFE	
			3" butterfly valve, PTFE	
BOLTS	SWINGBOLT	mm(length)	66mm	
			87mm	
			95mm	
FLANGES	FLANGES	stainless steel	1&1/2" ball valve flange	
			2&1/2" ball valve flange	



			3" ball valve flange	
			3" relief vavle flange	
VALVES	BALL VALVES	stainless steel	1&1/2" ball valve	
			2&1/2" ball valve	
			3" ball valve	
	BUTTERFLY VALV	stainless steel	1" butterfly valve	
			1&1/2" butterfly valve	
			2" butterfly valve	
	RELIEF VAVLES	stainless steel	1&1/2" relief vavle	